

引领3G生活

中国移动技术创新引擎

中国移动技术
引领3G生活

引领3G生活

引领3G生活



中国移动技术创新引擎

中国移动技术创新引擎

引领3G生活



The Application of TTCN-3 in Mobile Data Services Testing

Ruiping Zhu

TTCN-3 User Conference 2010
June 8-10 2009, Beijing, CHINA

Content



- ⑥ Introduction
- ⑥ Testing on Mobile Data Services
- ⑥ Testing Tools Based on TTCN-3
- ⑥ Conclusion

Introduction



- As the 3G(3rd Generation Mobile Telecommunications) has been deployed all over the world, various data services have a good opportunity to rapidly develop .
- The future revenue of mobile operators depends remarkably on the development of the data services, especially applications based on the mobile Internet which are blue ocean for the operators.

Introduction

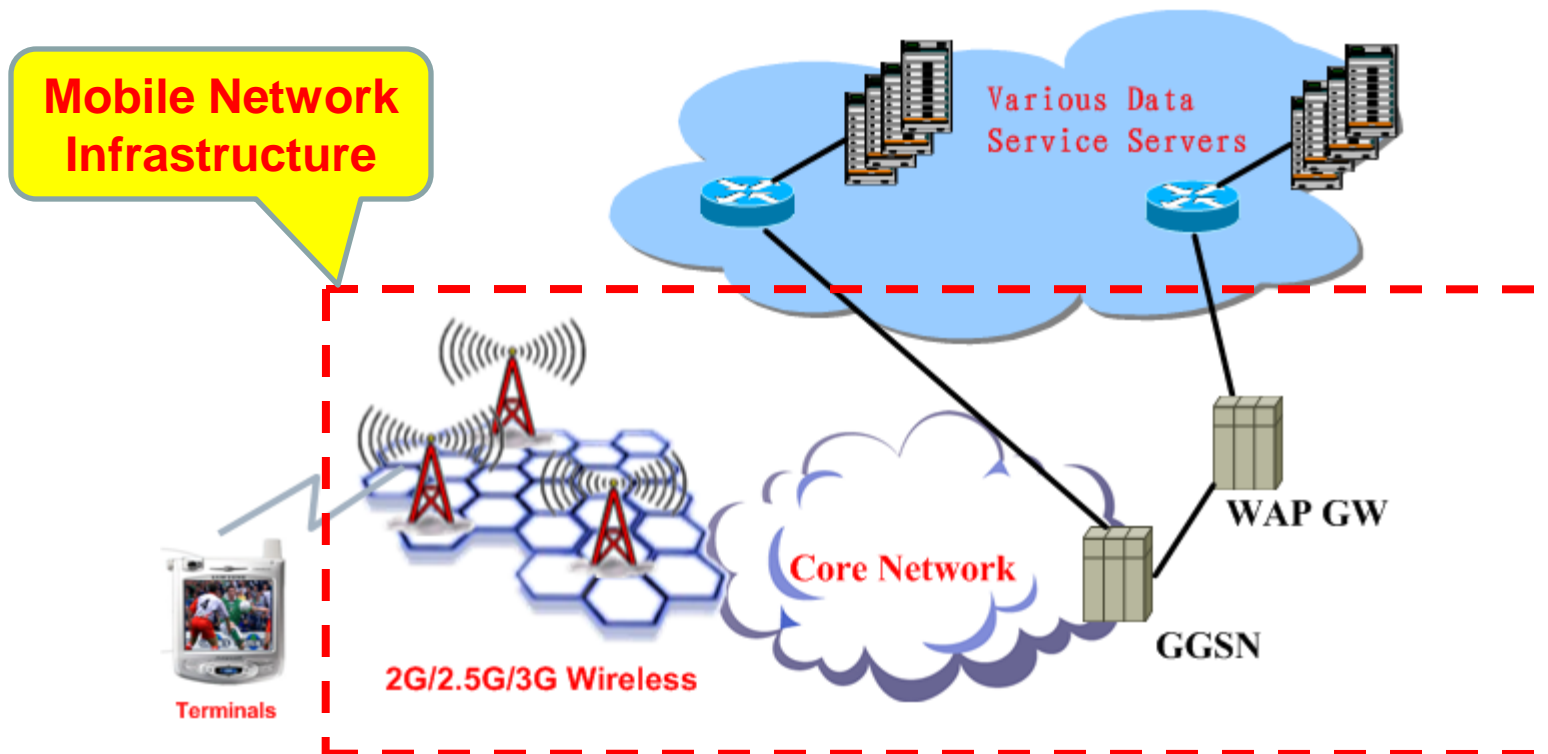

Architecture of mobile data services

Testing on Mobile Data Services



- There are two types of SUT(System Under Test):
 - one is data service server
 - the other is mobile terminal's client

- There are many types of testing :
 - Conformance testing of protocols between terminal's client and server
 - IOT between terminal's client and server
 - Functional testing of terminal's client or server
 - Simultaneous performance testing of server
 -

Testing Tools based on TTCN-3



□ Since 2008 the China Mobile Research Institute(CMRI) started to develop tools based on TTCN-3 to test interface protocol conformance between mobile terminals and server for several mobile data services such as Mobile TV , Mobile Payment, M2M and so on.

The tools have been successfully applied in practical testing. And we have found some bugs and errors in the SUT.

□ For every **interface I** connecting network elements A and B in one service, we have developed two tools:

- One tool is to simulate A to test B
- The other tool is to simulate B to test A

**Mobile Data
Services
Infrastructure**

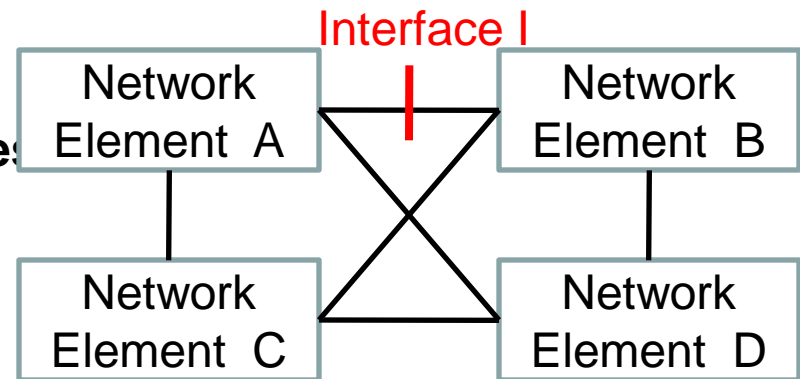

内部资料 注意保密

Testing Tools based on TTCN-3



The followings are the Testing tools we have developed and applied:

Services	Interface	Target Testing Tools	Protocol Adapter	En/Decoder Adapter
Mobile TV	between terminal's client and MBBMS server	tool1: simulate MBBMS server to test terminal	HTTP/TCP/IP	XML
		tool2: simulate terminal to test MBBMS server	HTTP/TCP/IP	XML
M2M	between sensor enabled communication and platform	tool1: simulate sensor to test platform	UDP/IP/GPRS	TLV
		tool2: simulate platform to test sensor enabled communication func.	UDP/IP/GPRS	TLV

Testing Tools based on TTCN-3



Let's take Mobile TV as an example:

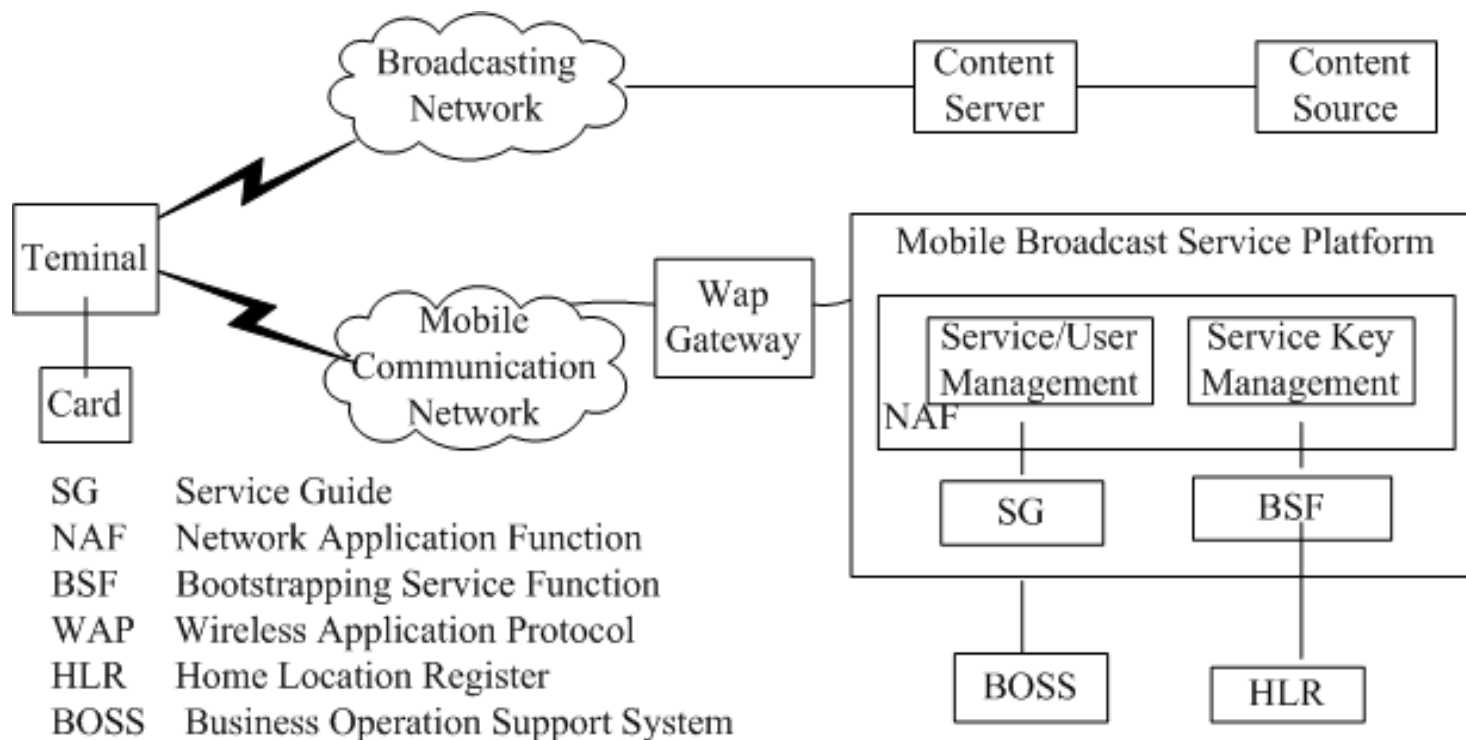

Fig.1. MBBMS Architecture

Testing Tools based on TTCN-3

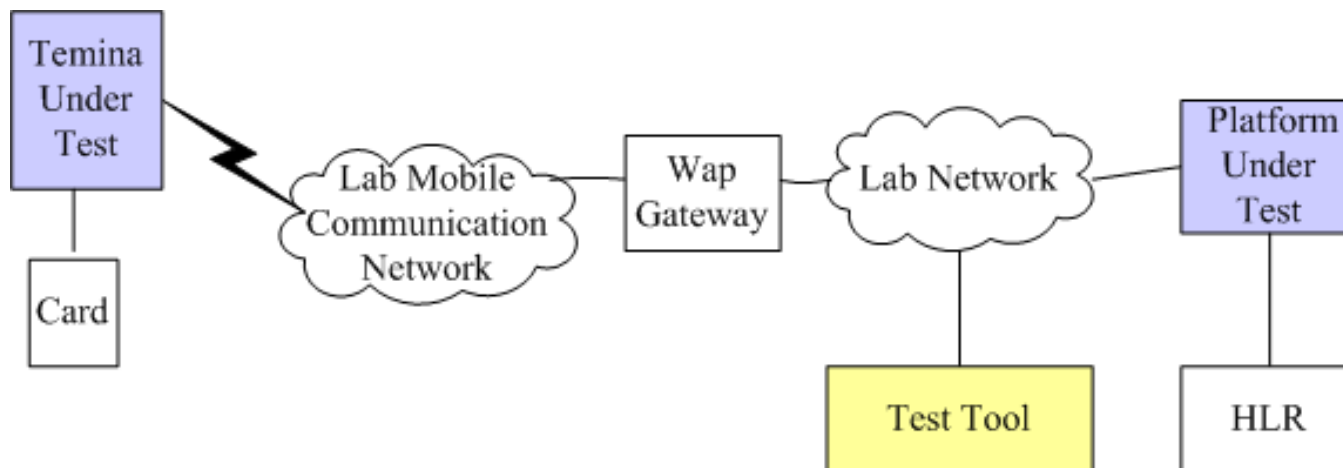

Fig.2. Test Environment for MBBMS

Testing Tools based on TTCN-3

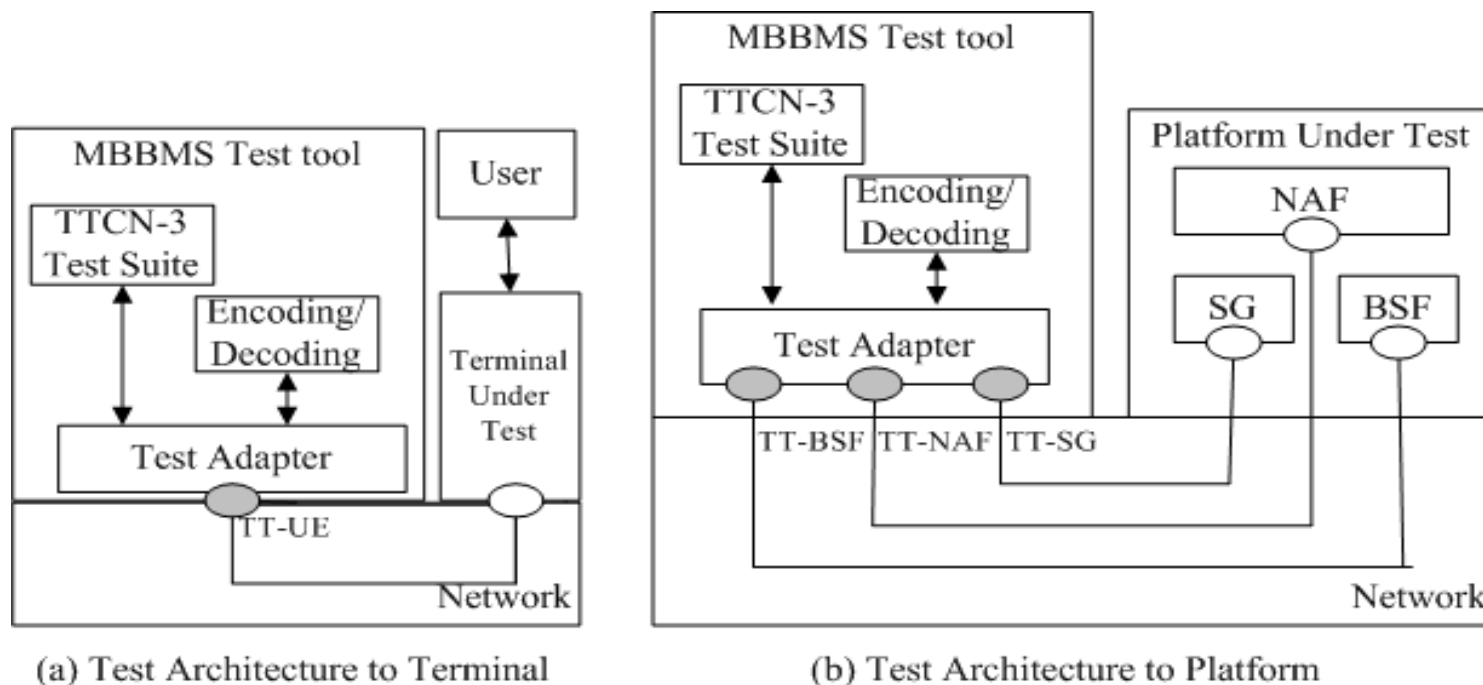

Fig.3. Test Architecture

Testing Tools based on TTCN-3

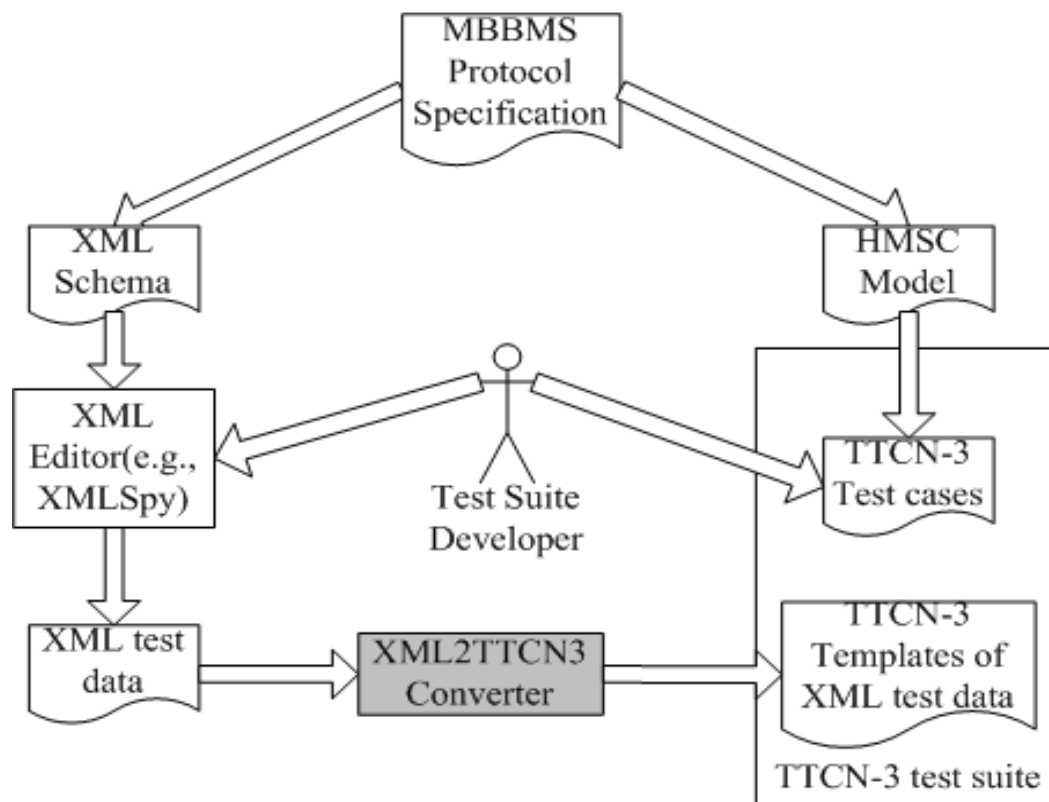

Fig.4. Design framework of MBBMS conformance test suite

Testing Tools based on TTCN-3

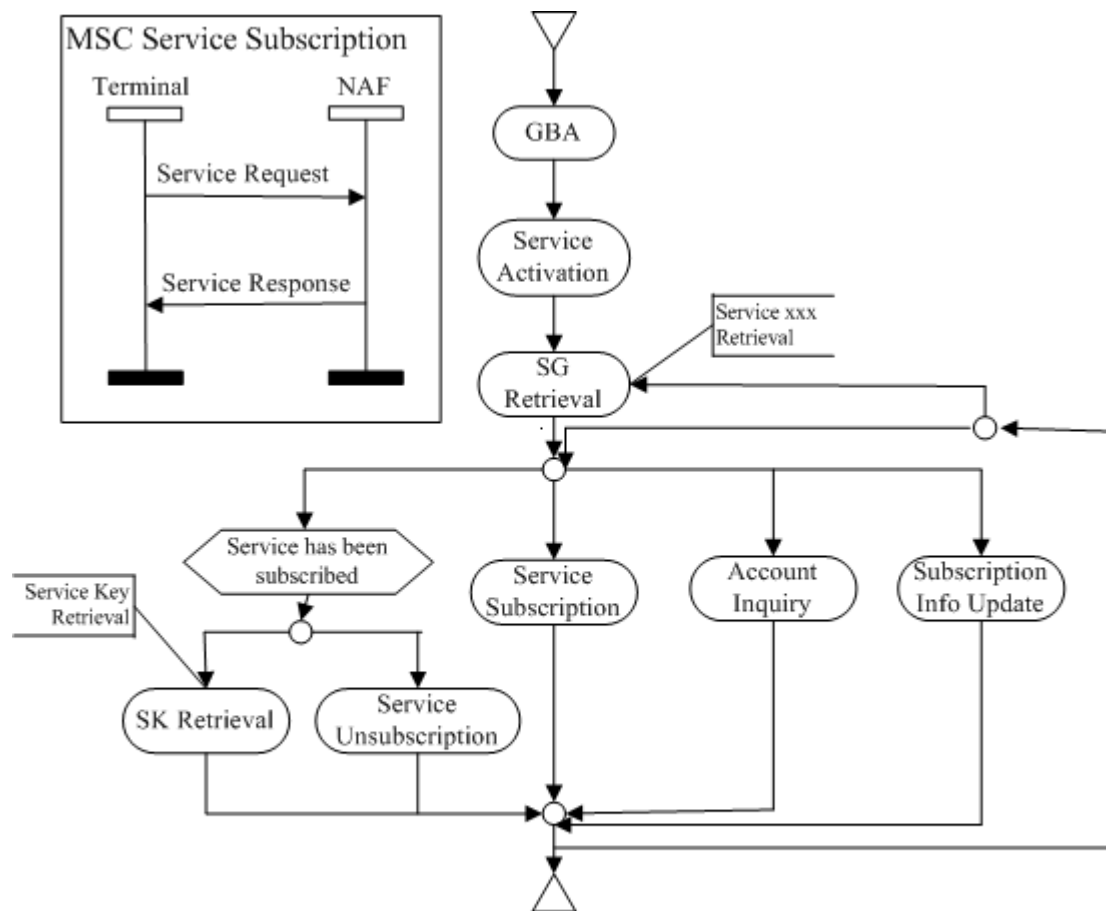

Fig.5. The simplified HMSC model of MBBMS

Testing Tools based on TTCN-3

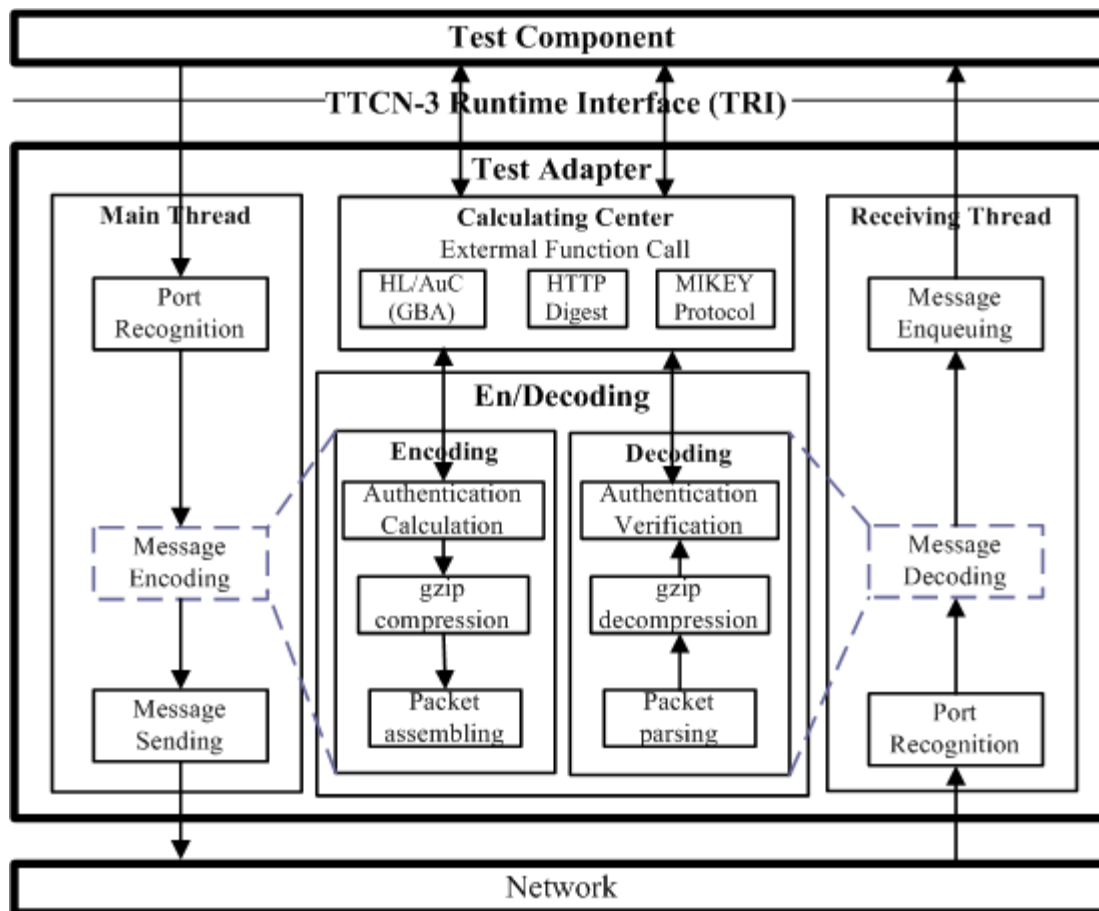

Fig.19. Test adapter and Encoding/Decoding modules structure

Testing Tools based on TTCN-3



No.	Test Groups	Test cases for terminal under test			Test cases for platform under test		
		#Normal	#Abnormal	#Total	#Normal	#Abnormal	#Total
1	GBA	1	3	4	2	3	5
2	Service Guide Retrieval	5	3	8	9	10	19
3	Subscribe Info Update	3	4	7	2	3	5
4	Service Activation	4	2	6	5	6	11
5	Service Subscription	2	4	6	2	4	6
6	Service Unsubscription	2	4	6	2	3	5
7	Account Inquiry	3	2	5	3	3	6
8	Service Key Retrieval	3	1	4	4	2	6
	Total	23	23	46	29	34	63

Test Suite Organization

Testing Tools based on TTCN-3



No.	Test Groups	Test Cases									
		#All	Ta			Tb			Tc		
			#Pass	#Fail	#Unsup	#Pass	#Fail	#Unsup	#Pass	#Fail	#Unsup
1	GBA	4	4	0	0	0	0	4	0	0	
2	Service Guide Retrieval	8	7	1	0	8	0	0	8	0	
3	Subscribe Info Update	7	7	0	0	3	3	1	5	1	
4	Service Activation	6	6	0	0	6	0	0	6	0	
5	Service Subscription	6	2	3	1	3	2	1	1	4	
6	Service Unsubscription	6	2	3	1	3	2	1	1	4	
7	Account Inquiry	5	0	0	5	0	0	5	4	1	
8	Service Key Retrieval	4	4	0	0	4	0	0	4	0	
	Total	46	32 (69.6%)	7 (15.2%)	7 (15.2%)	31 (67.3%)	7 (15.2%)	8 (17.4%)	33 (71.8%)	10 (21.8%)	3 (6.5%)

Test Results of Terminals under test

Testing Tools based on TTCN-3



No.	Test Groups	Test Cases									
		#Tested	Pa		Pb		Pc		Pc		
			#Pass	#Fail	#Pass	#Fail	#Pass	#Fail	#Pass	#Fail	
1	GBA	5	4	1	4	1	5	0	4	1	
2	Service Guide Retrieval	6	6	0	4	2	6	0	6	0	
3	Subscribe Info Update	2	2	0	2	0	2	0	2	0	
4	Service Activation	0	-	-	-	-	-	-	-	-	
5	Service Subscription	2	0	2	2	0	2	0	0	2	
6	Service Unsubscription	2	0	2	2	0	2	0	0	2	
7	Account Inquiry	3	3	0	3	0	3	0	3	0	
8	Service Key Retrieval	6	2	4	6	0	6	0	4	2	
	Total	26	17 (65.4%)	9 (34.6%)	23 (88.5%)	3 (11.5%)	26 (100%)	0 (0%)	19 (73.1%)	7 (26.9%)	

Test Results of Platforms under test

Conclusion



- **Conformance testing plays an increasingly important role in guaranteeing the quality of implementation of terminals and servers. The testing can precisely verify whether IUT has been implemented according to relevant specifications, which is considerably important in telecommunication industry.**
- **Testing tools is of great importance for conformance testing. To some extent, the efficiency of conformance testing depends on the quality of testing tools.**
- **Our practical experience shows that TTCN-3 is an effective standard and means to research and develop testing tools.**

引领3G生活

中国移动技术创新引擎

中国移动技术创新引擎

中国移动技术
引领3G生活

引领3G生活

Thank You



中国移动技术创新引擎

引领3G生活

引领3G生活